

ELECTRICAL SPECIFICATIONS

Nominal Voltage	120Vac
Max. Operating Voltage (MCOV)	150Vac
Max. Line Current	500mA (Phone & Fax); 300mA (DSL)
Max. Discharge Current	30kA per Pair (Phone); 40kA per Pair (DSL)
Max. Surge Current	24kA per Pair (Phone); 20kA per Pair (DSL)
Frequency	Up to 1GHz
Operating Temperature	-40°C to 85°C

MECHANICAL SPECIFICATIONS

Termination Method	110 Punch down Block
Disconnect Indication	Transmission Interrupt
Enclosure	UL94-V2 ABS Plastic
Dimensions	See Fig. C
Mounting	Flange Mount
Install Location	Indoor

LIMITED SUPPRESSION WARRANTIES

THOR SYSTEMS, INC. warrants to the original purchaser/end user that this Surge Protective Device (SPD/TVSS), if purchased and used solely in the continental United States, will be free from defects in materials and workmanship for a period of five (5) years from the date of purchase. During such limited warranty period, THOR SYSTEMS will not charge the original purchaser/end user to repair or replace the product, or a part or component therein (with the same or a similar product, part or component) at THOR SYSTEMS' option, any product, part or component which proves to have a defect in materials or workmanship, provided the product, part or component is returned prepaid, at the cost and expense of the purchaser/end user, to THOR SYSTEMS, INC.'S manufacturing facility in Richmond, Virginia, within the limited warranty period. All costs and expenses incurred in connection with the removal, shipment, handling and reinstallation of the repair or replaced product, part or component, as well as diagnosis, shall be borne by the purchaser/end user. A Return Material Authorization (RMA) number must be obtained from the Company's customer service department before returning any products.

At the request of the purchaser/end user, and at the cost and expense of the purchaser/end user (at our currently published rates, portal-to-portal), and with reasonable expectation of payment, THOR SYSTEMS, INC. will: (a) provide assistance in the diagnosis, removal, and reinstallation of a repaired or replaced product, part or component; (b) undertake to repair or replace any product, part or component at a location other than THOR SYSTEMS' manufacturing facility in Richmond, Virginia.

The foregoing limited warranties shall not apply unless a Warranty Registration Card is completed and returned via mail, fax, or email to THOR SYSTEMS, INC. within thirty (30) days of the date of purchase. The foregoing limited warranties shall not apply if the product, or any parts or components, are modified, tampered with, misused, misapplied, or subjected to abnormal working conditions (including, but not limited to, water or other overexposure). The limited warranty for repaired product or replacement product, parts or components will be only the remaining portion of the original limited warranty.

THESE LIMITED WARRANTIES DO NOT GUARANTEE UNINTERRUPTED SERVICE. REPAIR OR REPLACEMENT AS PROVIDED UNDER THESE LIMITED WARRANTIES ARE THE EXCLUSIVE REMEDY OF THE PURCHASER/END USER. THESE LIMITED WARRANTIES ARE IN LIEU OF ALL OTHER WARRANTIES, EXPRESSED OR IMPLIED, INCLUDING, BUT NOT LIMITED TO, ANY IMPLIED WARRANTY OF MERCHANTABILITY OR FITNESS FOR A PARTICULAR USE OR PURPOSE: ALL OF WHICH ARE HEREBY EXCLUDED AND EXPRESSLY DISCLAIMED. THOR SYSTEMS, INC. SHALL IN NO EVENT BE LIABLE FOR ANY SPECIAL, INDIRECT, INCIDENTAL, PUNITIVE, OR CONSEQUENTIAL DAMAGES OF ANY KIND OR CHARACTER, INCLUDING, WITHOUT LIMITATION, LOSS OF REVENUE OR PROFITS, FAILURE TO REALIZE SAVINGS OR OTHER BENEFITS, LOSS OF DATA OR USE, DAMAGE TO EQUIPMENT AND CLAIMS AGAINST THE PURCHASER/END USER BY ANY THIRD PERSON, EVEN IF THOR SYSTEMS, INC. HAS BEEN ADVISED OF THE POSSIBILITY OF SUCH DAMAGES. THOR SYSTEMS, INC.'S TOTAL LIABILITY ON ANY CLAIM MADE AGAINST IT SHALL NOT IN ANY EVENT EXCEED THE PURCHASE PRICE PAID TO THOR SYSTEMS, INC. FOR THE DEFECTIVE PRODUCT.



THOR SYSTEMS, INC.
3621 Saunders Avenue
Richmond, VA 23227-4354
Ph 804.355.1100 - www.thorsystems.us

Series TSdt PB110

Operation Manual

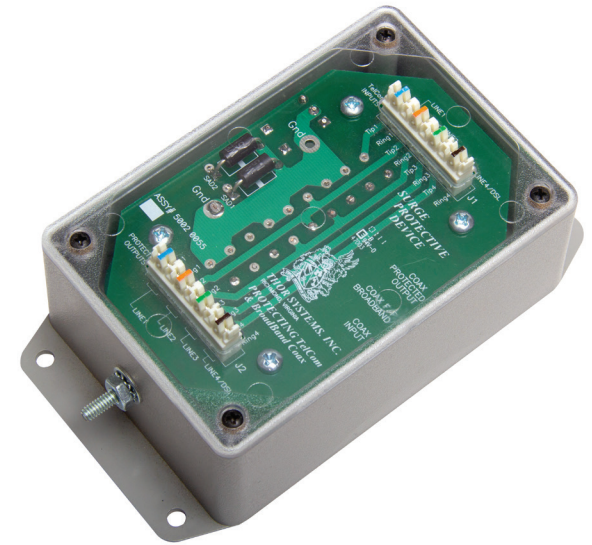

** Image is not model specific **

THOR SYSTEMS continuously strives to improve its products. Occasionally there may be changes in features or optional equipment. All information contained in this printed material is based on the latest product information available at the time of printing. THOR SYSTEMS reserves the right to implement changes, without notice, in specifications and equipment services.

Fig. A__ - CONNECTION METHOD

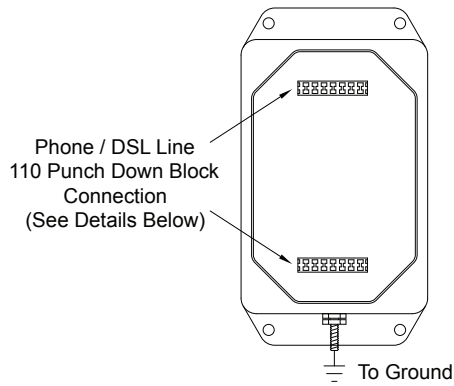

DETAILED VIEW:
110 Punch Down Blocks

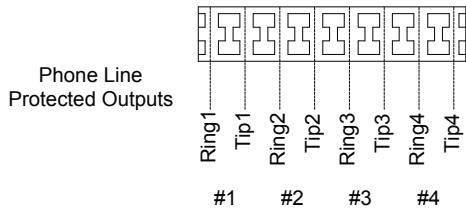
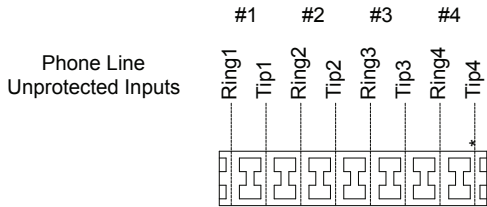

* For DSL lines, use Phone Line #4

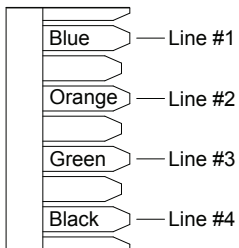

110 Punch Down Blocks Details:
 > Color Coded per Pair
 > Accepts #22AWG - 26AWG Solid Copper Wire
 > Contacts: Copper Alloy, Tin Plated

Fig. B - TECHNOLOGY / SCHEMATIC

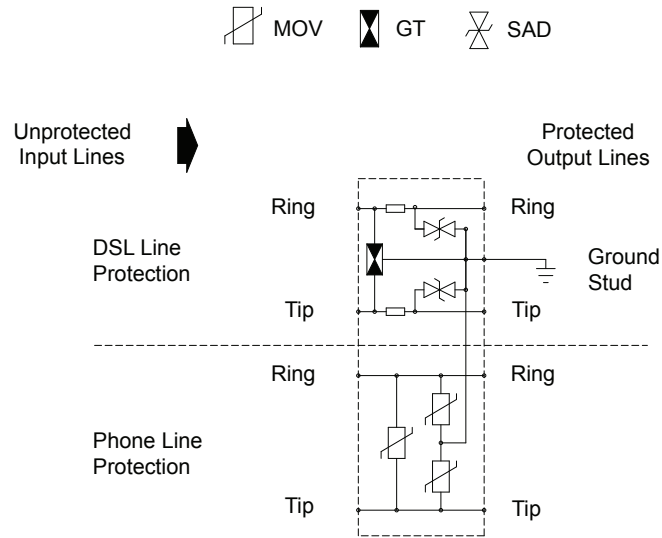

INSTALLATION

Example of Phone & Coax Installation

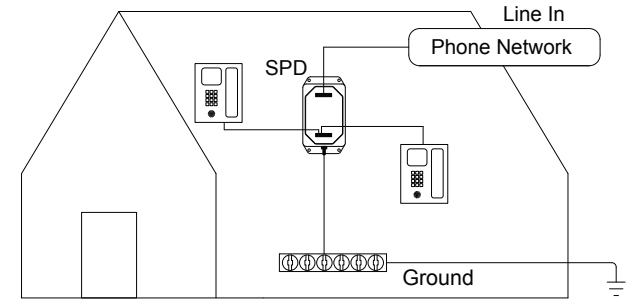
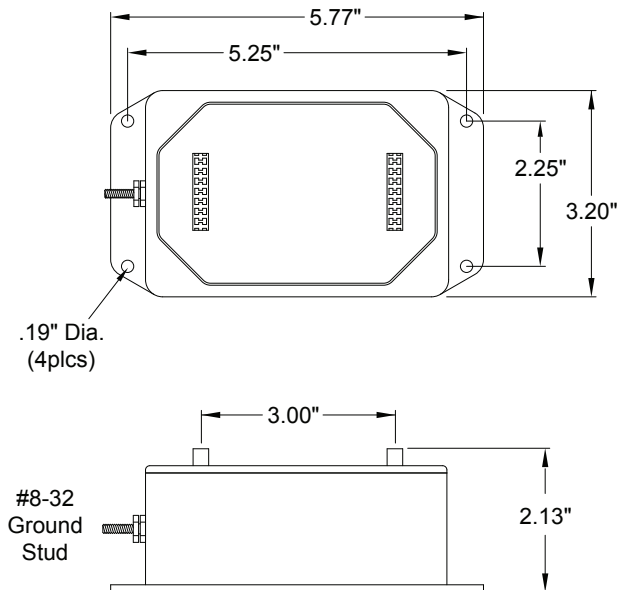

Fig. C - DIMENSIONS



SPD FAILURE INDICATION

If you experience an interruption to your network service, that could indicate your SPD has failed. If it is determined that the service interruption is due to a failed SPD, replace or bypass the failed SPD to restore service.