

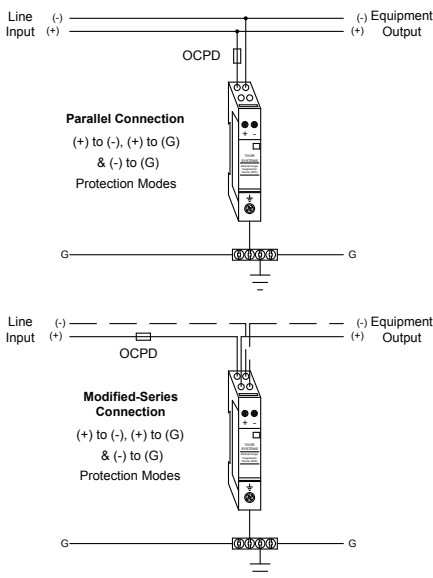


\*\* Image is not model specific \*\*

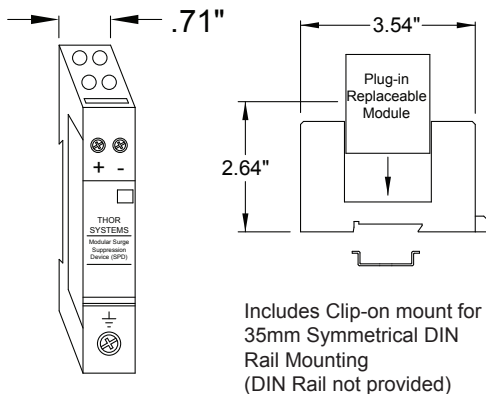
### 95Vdc Surge Protective Device (SPD)

- General Duty DC SPD
- 12Vdc ñ 350Vdc
- Wired in Parallel or Modified-Series
- 20, 30 or 40kA Rated
- 3 Protection Modes
- DIN Rail Mount
- Screw Terminal Connection

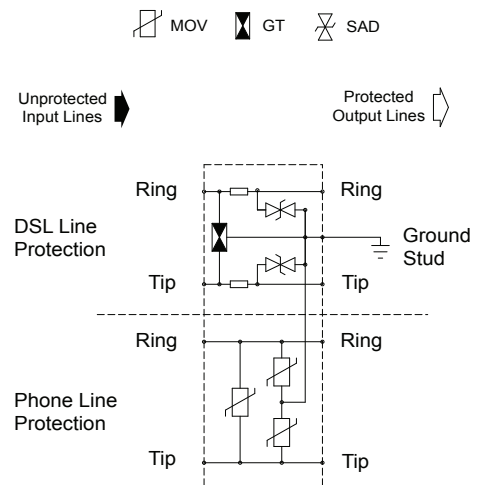
**Fig. A - CONNECTION METHOD**



**Fig. C - DIMENSIONS**

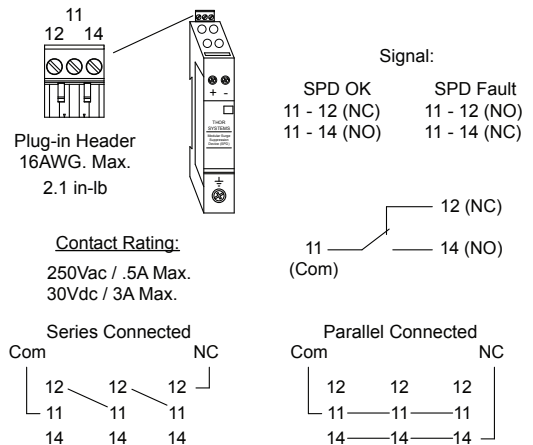


**Fig. B - TECHNOLOGY / SCHEMATIC**



**Fig. D - FORM C CONTACT**

Remote Signal for disconnect indication



## GENERAL INFORMATION

Application	DC Circuit SPD
Connection Method	Fig. A - Parallel or Modified-Series
Technology	Fig. B - Metal Oxide Varistor (MOV)
Protection Modes	(+) to (-); (+) to (G); (-) to (G)
Modular	Yes
Agency	UL1449 Recognized 4CA
Warranty	2 Years

## ELECTRICAL INFORMATION

Nominal Voltage	95Vdc
Max. Operating Voltage (MCOV)	125V
Maximum Surge Current	40kA
Max. Line Current (OCPD Size)	20A
Nominal Discharge Current (In)	20kA
Operating Temperature	-40°C to 85°C
Form C Contact	Fig. D - 250Vac / .5a Max (30Vdc / 3a Max)

## MECHANICAL INFORMATION

Termination Method	Screw Terminals: (+) & (-) (#8 - #14AWG); Ground (#4 - #12AWG)
Disconnect Indication	Visual Indication & Form C Contact
Housing	Thermoplastic NEMA 2 (IP20)
Dimensions	Fig. C - .71"W x 3.54"D x 2.64"H
Mounting	35mm Symmetrical DIN Rail
Outdoor Use	No
ROHs Compliant	Yes

## LIMITED SUPPRESSION WARRANTIES

THOR SYSTEMS, INC. warrants to the original purchaser/end user that this Surge Protective Device (SPD/TVSS), if purchased and used solely in the continental United States, will be free from defects in materials and workmanship for a period of five (5) years from the date of purchase. During such limited warranty period, THOR SYSTEMS will not charge the original purchaser/end user to repair or replace the product, or a part or component therein (with the same or a similar product, part or component) at THOR SYSTEMS' option, any product, part or component which proves to have a defect in materials or workmanship, provided the product, part or component is returned prepaid, at the cost and expense of the purchaser/end user, to THOR SYSTEMS, INC.'S manufacturing facility in Richmond, Virginia, within the limited warranty period. All costs and expenses incurred in connection with the removal, shipment, handling and reinstallation of the repair or replaced product, part or component, as well as diagnosis, shall be borne by the purchaser/end user. A Return Material Authorization (RMA) number must be obtained from the Company's customer service department before returning any products.

At the request of the purchaser/end user, and at the cost and expense of the purchaser/end user (at our currently published rates, portal-to-portal), and with reasonable expectation of payment, THOR SYSTEMS, INC. will: (a) provide assistance in the diagnosis, removal, and reinstallation of a repaired or replaced product, part or component; (b) undertake to repair or replace any product, part or component at a location other than THOR SYSTEMS' manufacturing facility in Richmond, Virginia.

The foregoing limited warranties shall not apply unless a Warranty Registration Card is completed and returned via mail, fax, or email to THOR SYSTEMS, INC. within thirty (30) days of the date of purchase. The foregoing limited warranties shall not apply if the product, or any parts or components, are modified, tampered with, misused, misapplied, or subjected to abnormal working conditions (including, but not limited to, water or other overexposure). The limited warranty for repaired product or replacement product, parts or components will be only the remaining portion of the original limited warranty.

THESE LIMITED WARRANTIES DO NOT GUARANTEE UNINTERRUPTED SERVICE. REPAIR OR REPLACEMENT AS PROVIDED UNDER THESE LIMITED WARRANTIES ARE THE EXCLUSIVE REMEDY OF THE PURCHASER/END USER. THESE LIMITED WARRANTIES ARE IN LIEU OF ALL OTHER WARRANTIES, EXPRESSED OR IMPLIED, INCLUDING, BUT NOT LIMITED TO, ANY IMPLIED WARRANTY OF MERCHANTABILITY OR FITNESS FOR A PARTICULAR USE OR PURPOSE: ALL OF WHICH ARE HEREBY EXCLUDED AND EXPRESSLY DISCLAIMED. THOR SYSTEMS, INC. SHALL IN NO EVENT BE LIABLE FOR ANY SPECIAL, INDIRECT, INCIDENTAL, PUNITIVE, OR CONSEQUENTIAL DAMAGES OF ANY KIND OR CHARACTER, INCLUDING, WITHOUT LIMITATION, LOSS OF REVENUE OR PROFITS, FAILURE TO REALIZE SAVINGS OR OTHER BENEFITS, LOSS OF DATA OR USE, DAMAGE TO EQUIPMENT AND CLAIMS AGAINST THE PURCHASER/END USER BY ANY THIRD PERSON, EVEN IF THOR SYSTEMS, INC. HAS BEEN ADVISED OF THE POSSIBILITY OF SUCH DAMAGES. THOR SYSTEMS, INC.'S TOTAL LIABILITY ON ANY CLAIM MADE AGAINST IT SHALL NOT IN ANY EVENT EXCEED THE PURCHASE PRICE PAID TO THOR SYSTEMS, INC. FOR THE DEFECTIVE PRODUCT.